

Compact Slide

MXH Series

ø6, ø10, ø16, ø20

RoHS

Allowable moment
Improved
by up to
240%

With new high rigidity linear guide

Allowable moment improvement illustrated below*

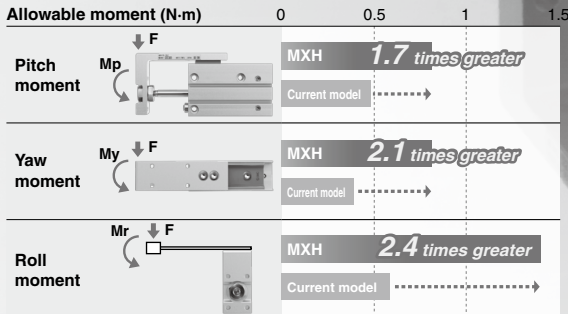

* Allowable moment caused by static load
(The above graph is a comparison between the new MXH and the current MXH6.)

Weight 19% reduced (ø20-10 stroke)

Current model: 455g → MXH: 369g

The weight has been reduced by incorporating a new high rigidity linear guide and piston.



- MXH
- MXS
- MXQ
- MXQ□
- MXQ
- MXF
- MXW
- MXJ
- MXP
- MXY
- MTS

D-□
-X□

High rigidity achieved with new circulating type linear guide

High allowable moment

Pitch Moment (N-m)

Bore size (mm)	MXH	MXH existing model
6	0.81	0.47
10	1.69	0.96
16	3.49	1.88
20	5.86	3.14

Yaw Moment (N-m)

Bore size (mm)	MXH	MXH existing model
6	0.81	0.39
10	1.69	0.82
16	3.49	1.59
20	5.86	2.75

Roll Moment (N-m)

Bore size (mm)	MXH	MXH existing model
6	1.4	0.59
10	3.19	1.37
16	6.47	2.75
20	11.66	5.49

* Selection of a bore size cannot be made only with above allowable moment. Select a bore size in accordance with "Model Selection" on pages 17 and 18.

Traveling parallelism is the same as the existing model.

Deflection at the extended position of the table is the same as the existing model.

Traveling parallelism	Stroke (mm)	
	5 to 30	40 to 60
	0.05 mm or less	0.1 mm or less

* Values when no load and no pressure applied.

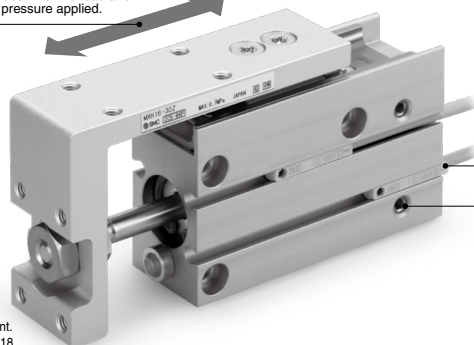

Small auto switches capable

(D-M9□, D-A9□)

Mounting is completely interchangeable with existing model.

Dimensions including workpiece mounting dimensions and cylinder mounting dimensions are the same as the existing model.

Mounting is possible in 4 directions.

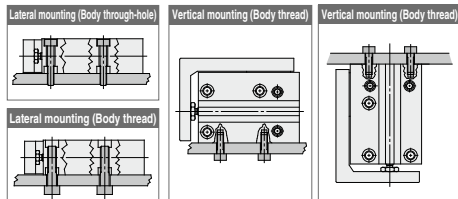

Piping is possible in 3 directions.

If changing the port location, "Made to Order" model (-XC3□) is available.

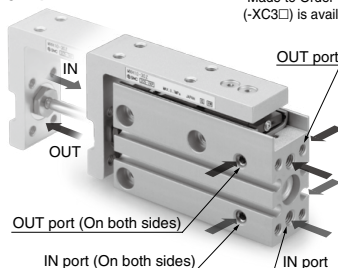

Application Example

Useful when long stroke/travel is required

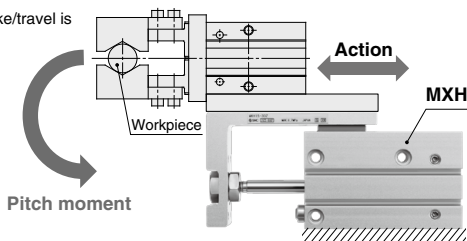

Series Variations

Model	Standard stroke (mm)								Made to Order	
	5	10	15	20	25	30	40	50		60
MXH6	●	●	●	●	●	●	●	●	●	-XC79 : Machining tapped hole, drilled hole and pin hole additionally -XB13 : Low speed cylinder (5 to 50 mm/s) -XC3□ : Special port location -XC19 : Intermediate stroke (Spacer type) -XC22 : Fluororubber seal
MXH10	●	●	●	●	●	●	●	●	●	
MXH16	●	●	●	●	●	●	●	●	●	
MXH20	●	●	●	●	●	●	●	●	●	

MXH Series Model Selection

Caution Confirmation of theoretical output is required separately. Refer to "Theoretical Output" on page 20.

Selection Conditions: Follow the tables below in order to determine selection conditions and choose one selection graph.

Mounting orientation	Vertical			Horizontal								
Maximum speed (mm/s)	Up to 100	Up to 300	Up to 500	Up to 100			Up to 300			Up to 500		
Load eccentricity L ₁ (mm)	—			50	100	200	50	100	200	50	100	200
Selection graph	1	2	3	4	5	6	7	8	9	10	11	12

- * L: Overhang (the distance from the cylinder shaft center to the load center of gravity)
The direction of L can also be a diagonal direction. (Refer to the drawing at right.)
- * H: Distance from the cylinder center axis to the mounting surface for the table

	MXH6	MXH10	MXH16	MXH20
H dimension (mm)	24.5	30.5	34.5	41.5

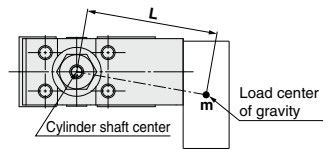

Selection Graph 1 to 3 (Vertical Mounting)

Graph 1 Maximum Speed 100 mm/s or Less

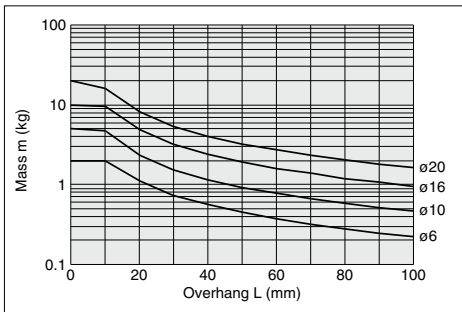

Graph 3 Maximum Speed 500 mm/s or Less

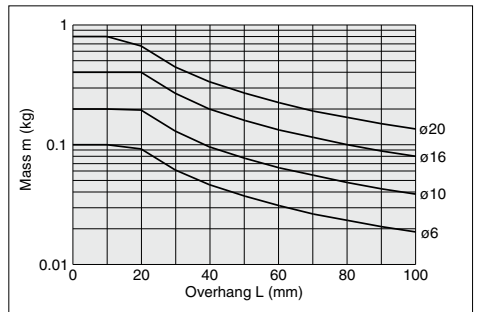

Graph 2 Maximum Speed 300 mm/s or Less

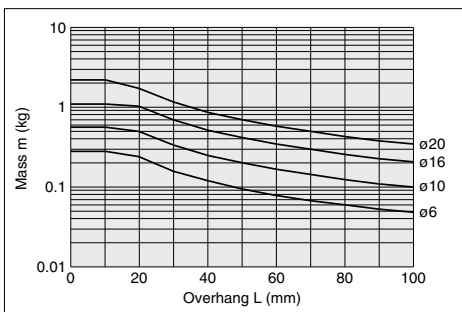

Selection Example (Vertical Mounting)

- Selection conditions
 - Mounting: Vertical
 - Maximum speed: 500 mm/s
 - Overhang L: 40 mm
 - Load mass m: 0.1 kg

Refer to Graph 3 based on vertical mounting and a speed of 500 mm/s.

In Graph 3, find the intersection of a 40 mm overhang L and load mass m of 0.1 kg, which results in a determination of ø16.

MXH
MXS
MXQ
MXQ
MXF
MXW
MXJ
MXP
MXY
MTS

D-
-X

MXH Series

Selection Graph 4 to 12 (Horizontal Mounting)

Maximum Speed 100 mm/s or Less

Graph 4 Load Eccentricity 50 mm

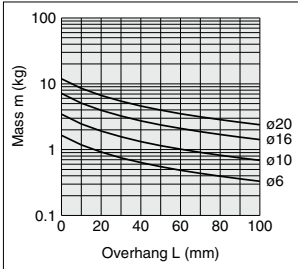

Maximum Speed 300 mm/s or Less

Graph 7 Load Eccentricity 50 mm

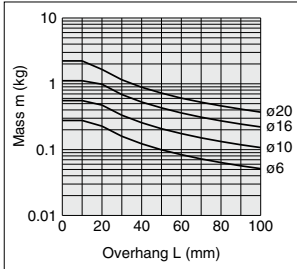

Maximum Speed 500 mm/s or Less

Graph 10 Load Eccentricity 50 mm

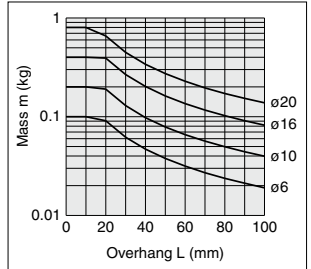

Graph 5 Load Eccentricity 100 mm

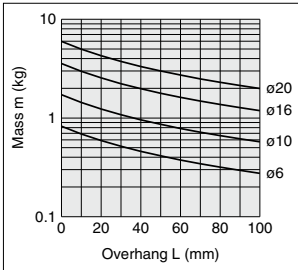

Graph 8 Load Eccentricity 100 mm

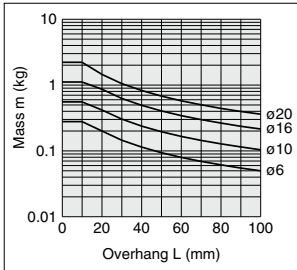

Graph 11 Load Eccentricity 100 mm

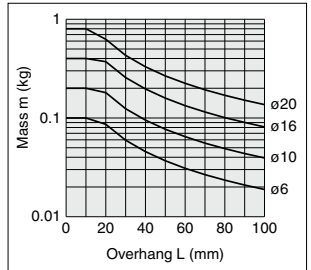

Graph 6 Load Eccentricity 200 mm

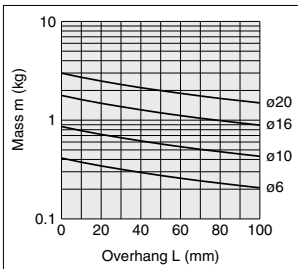

Graph 9 Load Eccentricity 200 mm

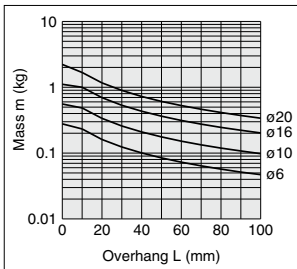

Graph 12 Load Eccentricity 200 mm

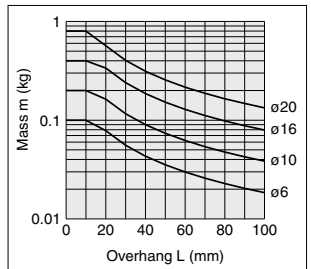

Selection Example (Horizontal Mounting)

2. Selection conditions
- Mounting: Horizontal
 - Maximum speed: 500 mm/s
 - Load eccentricity L₁: 50 mm
 - Overhang L: 30 mm
 - Load mass m: 0.1 kg

Refer to Graph 10 based on horizontal mounting, a speed of 500 mm/s and load eccentricity L₁ of 50 mm. In Graph 10, find the intersection of a 30 mm overhang L and load mass m of 0.1 kg, which results in a determination of ø10.

Compact Slide

MXH Series

ø6, ø10, ø16, ø20



How to Order

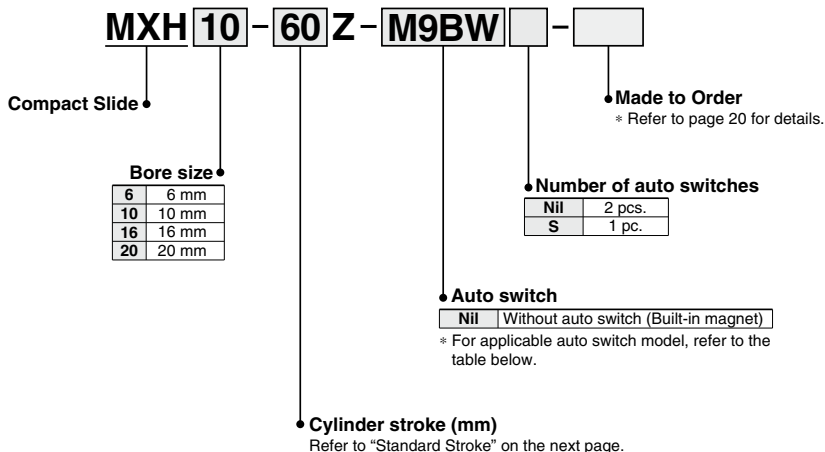

- MXH
- MXS
- MXQ
- MXQ
- MXF
- MXW
- MXJ
- MXP
- MXY
- MTS

Applicable Auto Switches/Refer to pages 1119 to 1245 for further information on auto switches.

Type	Special function	Electrical entry	Indicator light	Wiring (Output)	Load voltage		Auto switch model		Lead wire length (m)					Pre-wired connector	Applicable load	
					DC	AC	Perpendicular	In-line	0.5 (Nil)	1 (M)	3 (L)	5 (Z)	IC circuit		Relay, PLC	
Solid state auto switch	—	Grommet	Yes	3-wire (NPN)	5 V,	—	M9NV	M9N	●	●	●	○	○	IC circuit	Relay, PLC	
				3-wire (PNP)	12 V		M9PV	M9P	●	●	●	○				
				2-wire	12 V		M9BV	M9B	●	●	●	○				
	3-wire (NPN)			5 V,	M9NVV		M9NV	●	●	●	○	IC circuit				
	3-wire (PNP)			12 V	M9PVV		M9PV	●	●	●	○					
	2-wire			12 V	M9BWW		M9BW	●	●	●	○	—				
Water resistant (2-color indicator)	Grommet	Yes	3-wire (NPN)	5 V,	M9NAV ^{*1}	M9NA ^{*1}	○	○	○	○	○	IC circuit				
			3-wire (PNP)	12 V	M9PAV ^{*1}	M9PA ^{*1}	○	○	○	○						
			2-wire	12 V	M9BAV ^{*1}	M9BA ^{*1}	○	○	○	○						
Reed auto switch	—	Grommet	Yes	3-wire (NPN equivalent)	—	5 V	A96V	A96	●	—	—	—	—	IC circuit	—	
				No	2-wire	24 V	12 V	100 V	100 V or less	A93V ^{*2}	A93	●	●	●	—	—
							A90V	A90	●	—	—	—	—	IC circuit		

*1 Water resistant type auto switches can be mounted on the above models, but in such case SMC cannot guarantee water resistance.

Please consult with SMC regarding water resistant type with the above model numbers.

*2 1 m type lead wire is only applicable to D-A93.

* Lead wire length symbols: 0.5 m Nil (Example) M9NW
 1 m M (Example) M9NWM
 3 m L (Example) M9NWL
 5 m Z (Example) M9NWZ

* Solid state auto switches marked with "○" are produced upon receipt of order.

* Refer to page 28 for applicable auto switches other than listed above.

* For details about auto switches with pre-wired connector, refer to pages 1192 and 1193.

* Auto switches are shipped together, (but not assembled).

- D-
- X-



Symbol
Rubber bumper

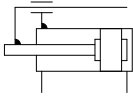

Made to Order
[Click here for details](#)

Symbol	Specifications
-XC79	Machining tapped hole, drilled hole and pin hole additionally
-XB13	Low speed cylinder (5 to 50 mm/s)
-XC3	Special port location
-XC19	Intermediate stroke (Spacer type)
-XC22	Fluororubber seal

Specifications

Bore size (mm)	6	10	16	20
Fluid	Air			
Action	Double acting			
Piping port size	M5 x 0.8			
Minimum operating pressure	0.15 MPa	0.06 MPa	0.05 MPa	
Maximum operating pressure	0.7 MPa			
Proof pressure	1.05 MPa			
Ambient and fluid temperature	Without auto switch: -10 to 70°C (No freezing) With auto switch: -10 to 60°C			
Piston speed	50 to 500 mm/s			
Allowable kinetic energy (J)	0.0125	0.025	0.05	0.1
Lubrication	Non-lube			
Cushion	Rubber bumper on both ends			
Stroke length tolerance	+1.0 0			
Auto switch (Option)	Solid state auto switch D-M9□, M9□W Reed auto switch D-A9□			

Standard Stroke

Bore size (mm)	Standard stroke (mm)
6, 10, 16, 20	5, 10, 15, 20, 25, 30, 40, 50, 60

(Note) Intermediate strokes are available with "Made to Order" model (-XC19).
(For details, refer to page 1346.)

Theoretical Output

Bore size (mm)	Rod size (mm)	Operating direction	Piston area (mm ²)	Operating pressure (MPa)		
				0.3	0.5	0.7
6	3	OUT	28	8	14	19
		IN	21	6	10	14
10	4	OUT	78	23	39	55
		IN	66	19	33	46
16	6	OUT	201	60	101	141
		IN	172	51	86	121
20	8	OUT	314	94	157	220
		IN	264	79	132	185

Weight

Model	Stroke (mm)								
	5	10	15	20	25	30	40	50	60
MXH6	61	66	75	80	88	93	107	120	134
MXH10	104	112	125	133	146	153	174	195	216
MXH16	194	204	222	232	250	260	288	316	343
MXH20	352	369	400	417	448	466	514	562	610

Table Displacement

Table Displacement due to Pitch Moment (Reference)

Table displacement (arrow) when a load acts upon the section marked with the arrow at the full stroke of the Compact Slide

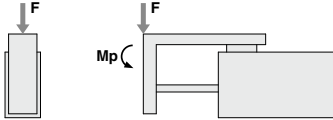

MXH6

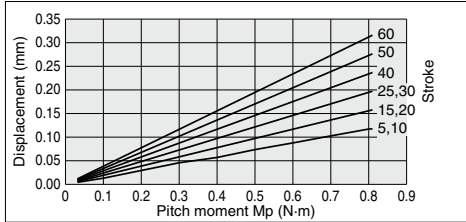

MXH10

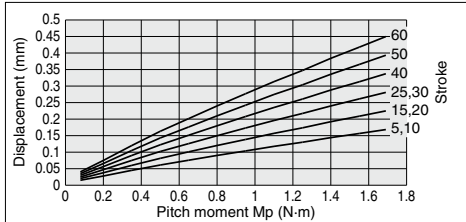

MXH16

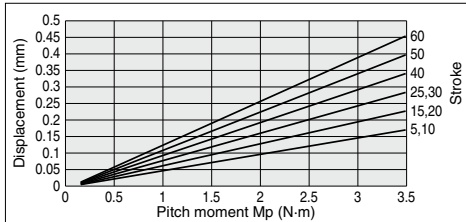

MXH20

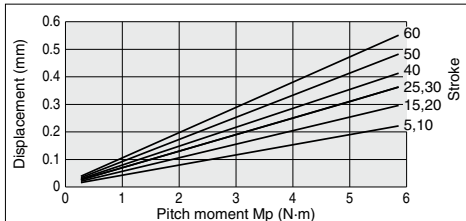
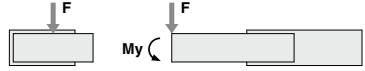
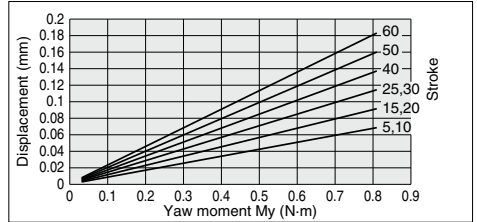

Table Displacement due to Yaw Moment (Reference)

Table displacement (arrow) when a load acts upon the section marked with the arrow at the full stroke of the Compact Slide



MXH6



MXH10

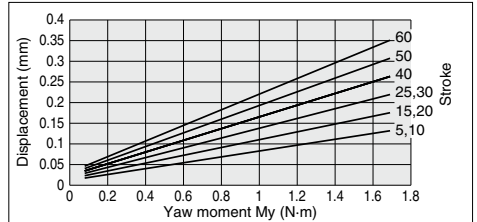

MXH16

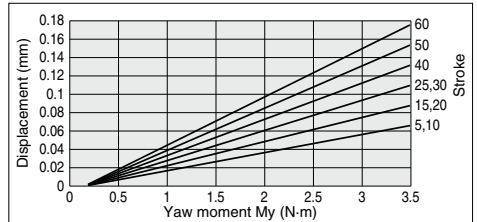

MXH20

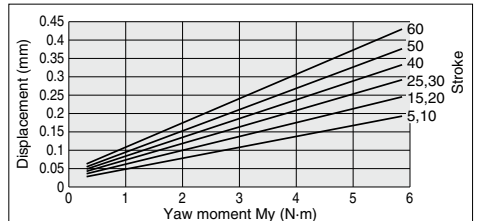

⚠ Caution Design

- Selection of a bore size cannot be made only with above graphs. Select a bore size in accordance with "Model Selection" on pages 17 and 18.
- Displacement may increase after an impact load has been applied. When the table is subjected to an impact load, there may be permanent distortion of the guide unit and increased displacement.

- MXH
- MXS
- MXQ
- MXQ
- MXF
- MXW
- MXJ
- MXP
- MXY
- MTS

- D-
- X

MXH Series

Table Displacement

Table Displacement due to Roll Moment (Reference)

Table displacement (at A) when a load acts upon section F at the full stroke of the Compact Slide

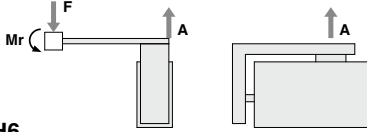

MXH6

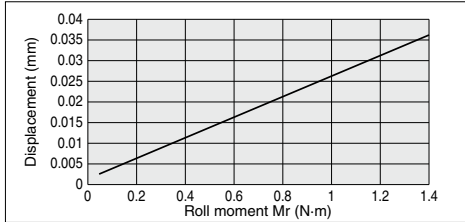

MXH10

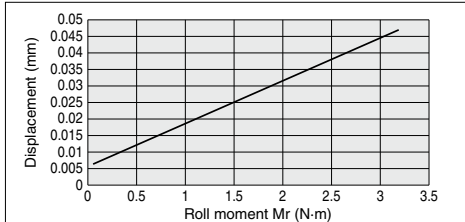

MXH16

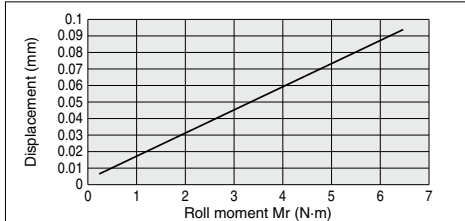

MXH20

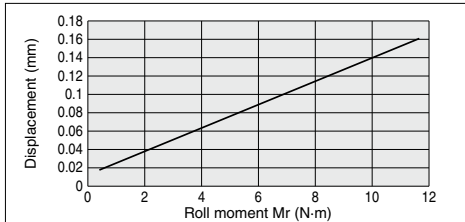

Table Accuracy

Traveling parallelism	Stroke (mm)	
	5 to 30	40 to 60
	0.05 mm or less	0.1 mm or less

* Values when no load and no pressure applied.

Allowable Moment

Model	Allowable moment (N-m)		
	Pitch moment Mp	Yaw moment My	Roll moment Mr
	MXH6	0.81	0.81
MXH10	1.69	1.69	3.19
MXH16	3.49	3.49	6.47
MXH20	5.86	5.86	11.66

Design

⚠ Caution

Selection of a bore size cannot be made only with above allowable moment. Select a bore size in accordance with "Model Selection" on pages 17 and 18.

Construction

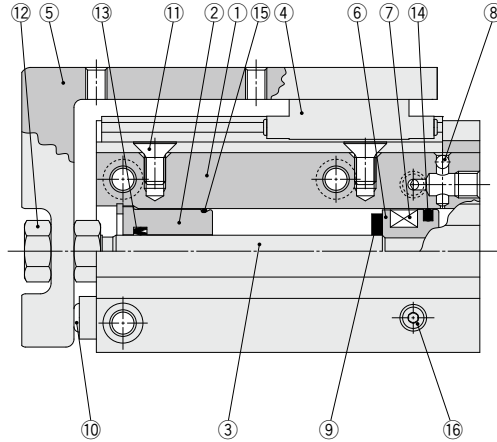

- MXH**
- MXS**
- MXQ**
- MXQ**
- MXF**
- MXW**
- MXJ**
- MXP**
- MXY**
- MTS**

Component Parts

No.	Description	Material	Note
1	Cylinder tube	Aluminum alloy	Hard anodized
2	Rod cover	Aluminum alloy	Hard anodized
3	Piston rod	Stainless steel	
4	Guide	The main parts are made of stainless steel.	
5	Table	Aluminum alloy	Hard anodized
6	Piston	Aluminum alloy	Chromated
7	Magnet	Magnetic material	
8	Steel ball	Carbon steel	
9	Bumper	Urethane	
10	Bumper	Urethane	
11	Countersunk head screw	Carbon steel	Nickel plating
12	Nut	Brass	Nickel plating
13	Rod seal	NBR	
14	Piston seal	NBR	
15	Gasket	NBR	
16	Plug	Carbon steel	Zinc chromated

Note) The MXH series cannot be disassembled.

- D**
- X**

MXH Series

Dimensions: Ø6

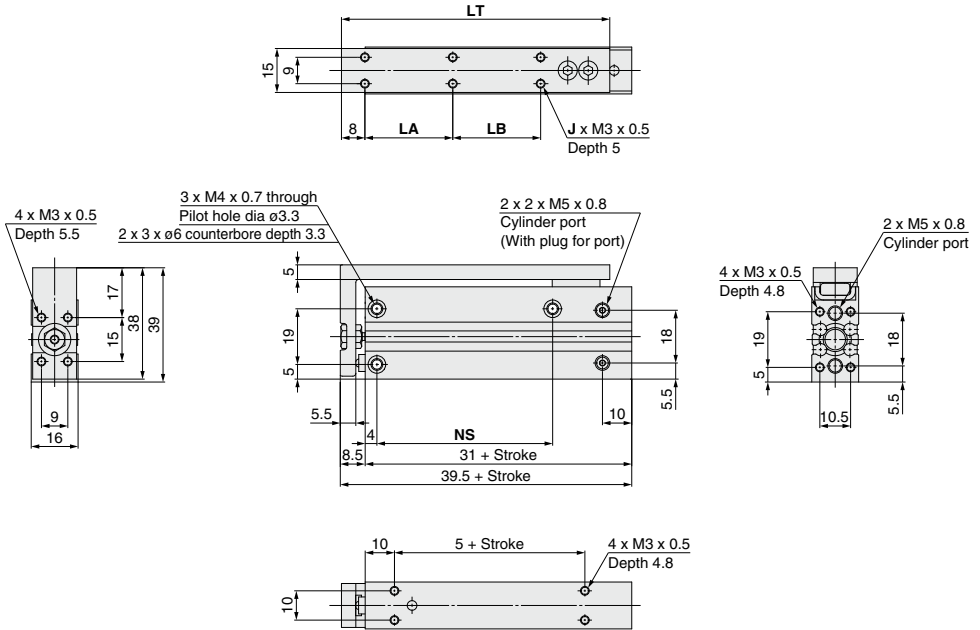

Note 1) Refer to "Specific Product Precautions" for mounting of the Compact Slide and a workpiece.
 Note 2) When changing the port location, please order a new port plug: MXH-P (2 pcs.)

Stroke (mm)	J	LA	LB	LT	NS
5	4	10	—	42	14
10	4	10	—	42	14
15	4	20	—	52	24
20	4	20	—	52	24
25	4	30	—	62	30
30	4	30	—	62	30
40	6	20	20	72	45
50	6	25	25	82	55
60	6	30	30	92	60

Dimensions: Ø10

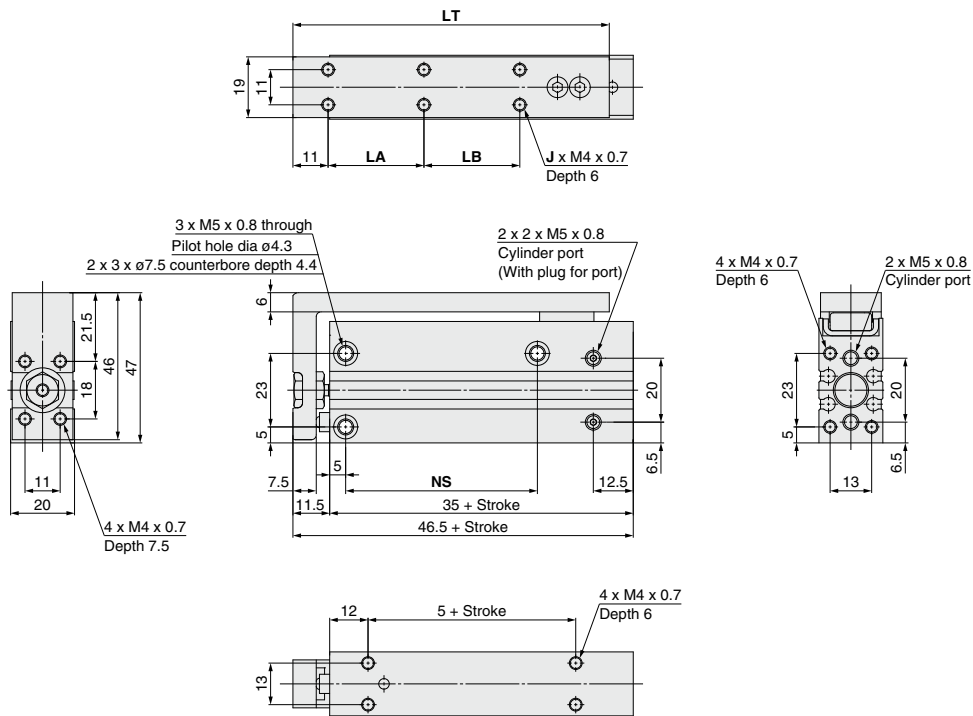

- MXH
- MXS
- MXQ
- MXQ
- MXF
- MXW
- MXJ
- MXP
- MXY
- MTS

Note 1) Refer to "Specific Product Precautions" for mounting of the Compact Slide and a workpiece.
 Note 2) When changing the port location, please order a new port plug: MXH-P (2 pcs.)

Stroke (mm)	J	LA	LB	LT	NS
5	4	10	—	49	14
10	4	10	—	49	14
15	4	20	—	59	24
20	4	20	—	59	24
25	4	30	—	69	30
30	4	30	—	69	30
40	6	20	20	79	45
50	6	25	25	89	55
60	6	30	30	99	60

- D-
- X

MXH Series

Dimensions: Ø16

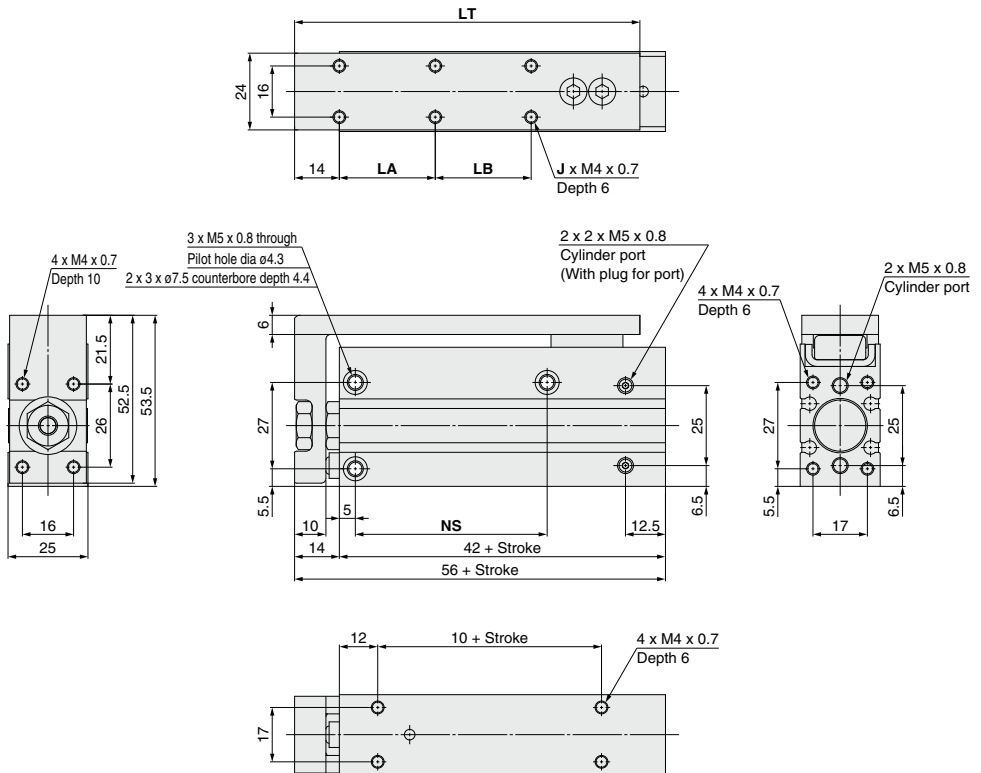

Note 1) Refer to "Specific Product Precautions" for mounting of the Compact Slide and a workpiece.
 Note 2) When changing the port location, please order a new port plug: MXH-P (2 pcs.)

Stroke (mm)	J	LA	LB	LT	NS
5	4	10	—	58	20
10	4	10	—	58	20
15	4	20	—	68	30
20	4	20	—	68	30
25	4	30	—	78	40
30	4	30	—	78	40
40	6	20	20	88	50
50	6	25	25	98	60
60	6	30	30	108	60

Dimensions: Ø20

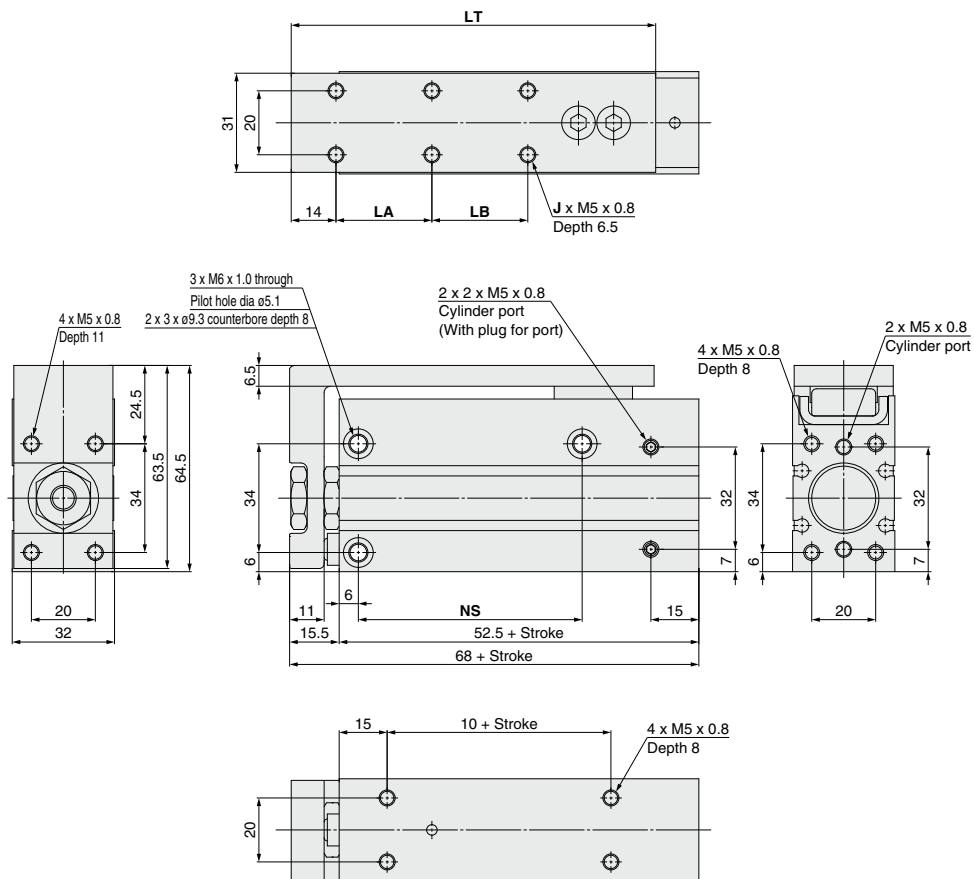

- MXH
- MXS
- MXQ
- MXQ
- MXF
- MXW
- MXJ
- MXP
- MXY
- MTS

Note 1) Refer to "Specific Product Precautions" for mounting of the Compact Slide and a workpiece.
 Note 2) When changing the port location, please order a new port plug: MXH-P (2 pcs.)

Stroke (mm)	J	LA	LB	LT	NS
5	4	10	—	64	20
10	4	10	—	64	20
15	4	20	—	74	25
20	4	20	—	74	25
25	4	30	—	84	40
30	4	30	—	84	40
40	6	20	20	94	50
50	6	25	25	104	70
60	6	30	30	114	70

- D-□
- X□

MXH Series Auto Switch Mounting

Minimum Stroke for Auto Switch Mounting

Number of auto switches mounted	Applicable auto switch model (mm)		
	D-M9□, M9□V	D-M9□W, M9□WV D-M9□A, M9□AV	D-A9□, A9□V
1 pc.	5	5	5
2 pcs.	5	10	10

Auto Switch Proper Mounting Position (Detection at Stroke End) and Its Mounting Height

D-M9□
D-M9□W
D-M9□A
D-A9□

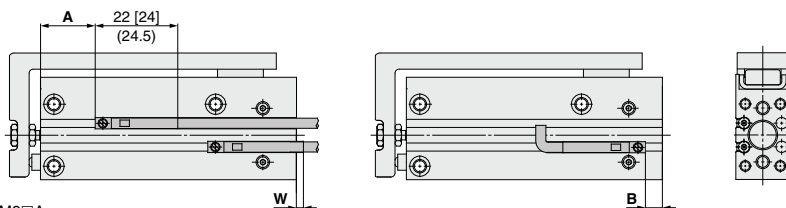

[] : Value of the D-M9□A
() : Value of the D-A90/A93

D-M9□V
D-M9□WV
D-M9□AV
D-A9□V

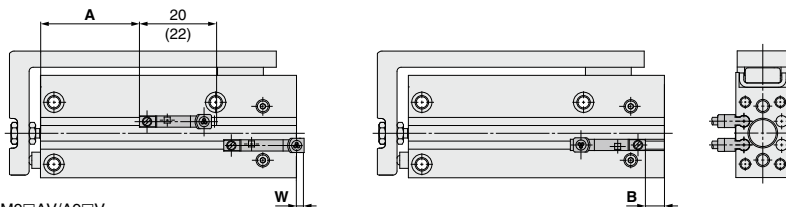

() : Value of the D-M9□AV/A9□V

Bore size (mm)	D-M9□W, D-M9□			D-M9□WV, D-M9□V			D-M9□A			D-M9□AV			D-A9□, D-A9□V		
	A	W	B	A	W	B	A	W	B	A	W	B	A	W	B
6	16.5	7.5	2.5	16.5	5.5	2.5	16.5	9.5	2.5	16.5	7.5	2.5	12.5	3.5 (6)	—
10	15.0	2.0	7.5	15.0	0	7.5	15.0	4.0	7.5	15.0	2.0	7.5	11.0	-2.0 (0.5)	3.5
16	22.0	2.0	8.0	22.0	0	8.0	22.0	4.0	8.0	22.0	2.0	8.0	18.0	-2.0 (0.5)	4.0
20	30.0	-0.5	10.5	30.0	-2.5	10.5	30.0	1.5	10.5	30.0	-0.5	10.5	26.0	-4.5 (-2)	6.5

Note 1) Negative figures in the table W indicate that an auto switch is mounted inward from the edge of the cylinder body.
 Note 2) In the case of models with 5 and 10 strokes, the auto switch may not turn off due to operating range or two auto switches may turn on simultaneously. Fix auto switches outside 1 to 4 mm further than the values in the table above. (If one auto switch is used, make sure that it turns ON and OFF properly; If two auto switches are used, make sure that both auto switches turn ON.)
 Note 3) () in column W denotes the D-A90/A93 dimensions.

Operating Range (mm)

Auto switch model	Bore size			
	6	10	16	20
D-M9□, M9□V D-M9□W, M9□WV D-M9□A, M9□AV	3	3.5	5	6
D-A9□, A9□V	5	6	9	11

* Values which include hysteresis are for guideline purposes only, they are not a guarantee (assuming approximately ±30% dispersion) and may change substantially depending on the ambient environment.

Other than the applicable auto switches listed in "How to Order", the following auto switches can be mounted.
 * Normally closed (NC = b contact) solid state auto switches (D-F9G/F9H) are also available. Refer to page 1137 for details.

Auto Switch Mounting

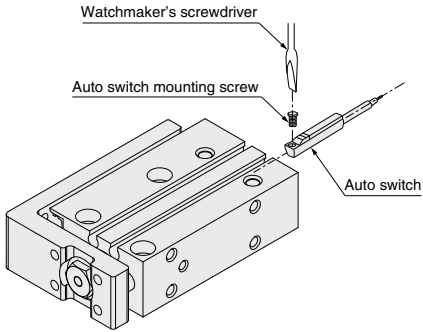

- When tightening the auto switch mounting screw, use a watchmaker's screwdriver with a handle 5 to 6 mm in diameter.

Tightening Torque of Auto Switch Mounting Screw (N·m)

Auto switch model	Tightening torque
D-A9□(V)	0.10 to 0.20
D-M9□(V) D-M9□W(V) D-M9□A(V)	0.05 to 0.15

Note) When used with side ported type, it is not possible to mount the D-A9□V/M9□V type on the side to which the piping is connected.

MXH

MXS

MXQ□

MXQ

MXF

MXW

MXJ

MXP

MXY

MTS

D-□

-X□



MXH Series

Specific Product Precautions 1

Be sure to read this before handling the products. Refer to back page 50 for Safety Instructions and pages 3 to 12 for Actuator and Auto Switch Precautions.

Auto Switch Mounting

When installing in close proximity to each other

⚠ Caution

- When the Compact Slide with the D-A9□ or D-M9□ auto switch is used, the auto switches could activate unintentionally if the installed distance is less than the dimension shown in Table (1). Therefore, make sure to provide at least this much clearance. Due to unavoidable circumstances, if they must be used with less distance than the dimensions given in the table below, the cylinders must be shielded. Therefore, affix a steel plate or a magnetic shielding plate (MU-S025) to the area on the cylinder that corresponds to the adjacent auto switch. (Please contact SMC for details.) The auto switch could activate unintentionally if a shielding plate is not used.

Table (1) (mm)

Bore size (mm)	d	L
MXH6	5	21
MXH10	5	25
MXH16	10	35
MXH20	15	47

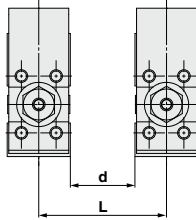

Dimensions of a shielding plate (MU-S025) that is sold separately are indicated as reference.

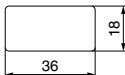

Material: Ferrite stainless steel, Thickness: 0.3 mm
Since the back side is treated with adhesive, it is possible to attach to the cylinder.

Operating Precautions

⚠ Warning

Be aware that smoking cigarettes etc., after your hands have come into contact with the grease used in this cylinder can create a gas that is hazardous to humans.

⚠ Caution

- Do not place your fingers in the clearance between the non-rotating plate and the cylinder tube. Your fingers could get caught between the table and the cylinder tube when the piston rod retracts. If fingers are caught in a cylinder, there is a danger of injury due to the strong cylinder output, and therefore, caution must be exercised.
- In terms of the work load and moment, operate the cylinder below the maximum work load and allowable moment.
- If the output of the Compact Slide is applied directly to the table, make sure it is applied along the rod axial line. (Refer to the figure below.)

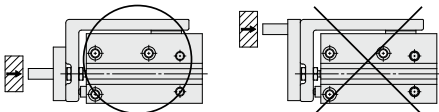

Operating Precautions

- Make sure to connect a speed controller and adjust it to a speed of 500 mm/s or less to operate the cylinder.
- If the vibration of the workpiece due to cylinder operation is clearly noticeable, recheck the operating conditions. Even when the moment applied to the product is under the allowable moment, the vibration width may be increased if a large amount of eccentric load is applied.

Operating Direction with Different Pressure Ports

⚠ Caution

- The Compact Slide can be piped in 3 directions. Check the pressure port and the operating direction. (Refer to the figure below.)
Change the plug location depending on the application. Confirm that there is no air leakage after changing the plug location. If there is slight leakage, remove the plug, check the seat surface and reassemble.

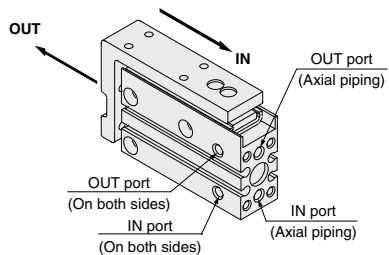

When changing the port location, please order the following plug. Replacement port plug part number: MXH-P (2 pcs.)

- If the plug is tightened excessively when attaching it to the axial piping of MXH6, it may be in contact with the internal steel ball, causing air leakage. As for the plug tightening guide, make the adjustment so that the plug sunk dimension from the cylinder tube surface is 0 to less than 1 mm.

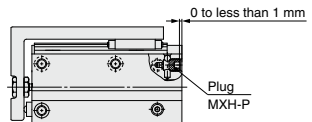

Backlash in the Stroke Direction

⚠ Caution

- Since the connection between the piston rod and table is a floating mechanism, the table has backlash of 0.15 mm or less in the stroke direction. (Refer to the figure on the right.)

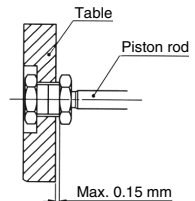

Connecting part of piston rod and table



MXH Series

Specific Product Precautions 2

Be sure to read this before handling the products. Refer to back page 50 for Safety Instructions and pages 3 to 12 for Actuator and Auto Switch Precautions.

Mounting

⚠ Caution

1. When tightening threads for the Compact Slide, properly tighten within the specified torque.

How to Mount the Compact Slide

The Compact Slide can be mounted in 4 directions. Make a selection suitable for the applicable machinery and work pieces, etc.

Lateral Mounting (Body through-hole)

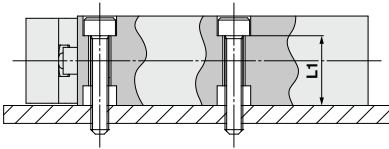

Model	Bolt	Maximum tightening torque (N·m)	L1
MXH6	M3 x 0.5	1.1	12.7
MXH10	M4 x 0.7	2.5	15.6
MXH16	M4 x 0.7	2.5	20.6
MXH20	M5 x 0.8	5.1	24.0

Lateral Mounting (Body thread)

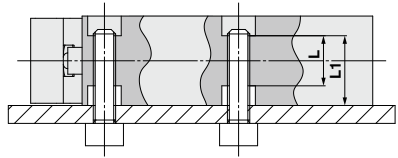

Model	Bolt	Maximum tightening torque (N·m)	L1	L
MXH6	M4 x 0.7	2.5	12.7	9.4
MXH10	M5 x 0.8	5.1	15.6	11.2
MXH16	M5 x 0.8	5.1	20.6	16.2
MXH20	M6 x 1	8.1	24.0	16.0

Vertical Mounting (Body thread)

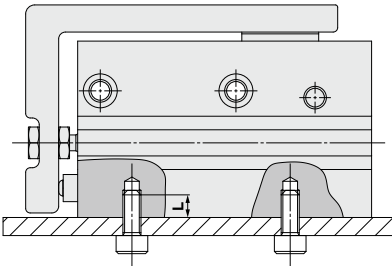

Model	Bolt	Maximum tightening torque (N·m)	L
MXH6	M3 x 0.5	1.1	4.8
MXH10	M4 x 0.7	2.5	6
MXH16	M4 x 0.7	2.5	6
MXH20	M5 x 0.8	5.1	8

Axial Mounting (Body thread)

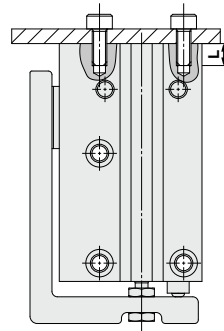

Model	Bolt	Maximum tightening torque (N·m)	L
MXH6	M3 x 0.5	1.1	4.8
MXH10	M4 x 0.7	2.5	6
MXH16	M4 x 0.7	2.5	6
MXH20	M5 x 0.8	5.1	8

MXH

MXS

MXQ

MXQ

MXF

MXW

MXJ

MXP

MXY

MTS

D-

-X



MXH Series

Specific Product Precautions 3

Be sure to read this before handling the products. Refer to back page 50 for Safety Instructions and pages 3 to 12 for Actuator and Auto Switch Precautions.

Mounting

⚠ Caution

1. When tightening threads for the Compact Slide, properly tighten within the specified torque.
2. When mounting a workpiece on the top of the table, do not screw a bolt in more deeper than the below table L dimension.
If screwing a bolt in more deeper than the L dimension, the edge of the bolt could reach the linear guide and might damage the linear guide.

How to Mount a Workpiece

Work pieces can be mounted on 2 surfaces of the Compact Slide.

Front Mounting

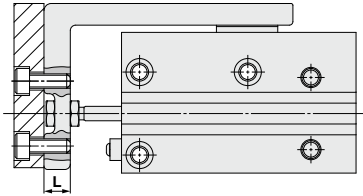

Top Mounting

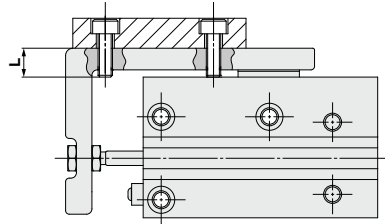

Model	Bolt	Maximum tightening torque (N-m)	L
MXH6	M3 x 0.5	1.1	5.5
MXH10	M4 x 0.7	2.5	7.5
MXH16	M4 x 0.7	2.5	10
MXH20	M5 x 0.8	5.1	11

Model	Bolt	Maximum tightening torque (N-m)	L
MXH6	M3 x 0.5	1.1	6.5
MXH10	M4 x 0.7	2.5	8
MXH16	M4 x 0.7	2.5	9
MXH20	M5 x 0.8	5.1	9.5

How to Mount a Workpiece

Work pieces can be mounted on 2 surfaces of the Compact Slide.

- Since the table is supported by the linear guide, take care not to apply strong impact or large moment, etc., when mounting work pieces.
- Hold the table when fastening work pieces to it with bolts etc. If the body is held while tightening bolts etc., the guide section will be subjected to a large moment, and there may be a loss of precision.

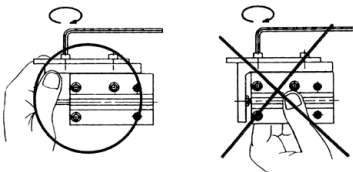

- For connection with a load having an external support/guide mechanism, select an appropriate connection method and perform careful alignment.
- Use caution, as scratches or nicks, etc., on the sliding parts of the piston rod can cause a malfunction and air leakage.